



Subject to technical changes.

© Copyright Zehnder Ltd

All rights, especially those of reproduction, dissemination and translation, are reserved.

No part of this publication may be reproduced in any form or by any means (printing, photocopying, microfilm, scanning or otherwise), or electronically processed, duplicated, stored or distributed without the prior written approval of Zehnder Group.

zehnder *radiavector*

General technical information	4
Product overview zehnder radiavector	6
Product description zehnder radiavector	7
Technical data zehnder radiavector :	
– Models 211–544	8
Pressure loss	9
Connection options	10
Series mounting	11
Connection dimensions	12
Fixing provisions	13
Accessories	15
Trench heating	18
Radiavector completo	19
Special configurations	20
Heat emission/technical data per 1000 mm	
zehnder radiavector :	
– Height 70 mm	21
– Height 140 mm	22
– Height 210 mm	23
– Height 280 mm	24
Special configuration examples	25
Conversion factors	26

Sizes, units of measurement, symbols (EN 442)

Symbol	Unit	Description
H	mm	Height
L	mm	Length
T	mm	Depth
H Lam.	mm	Height of fins
N	mm	Distance between connections
A	m ²	Surface area
V	dm ³	Water capacity
M	kg	Empty weight
E	-	Number of elements
t ₁	°C	Flow temperature
t ₂	°C	Return temperature
t _r	°C	Room temperature
t _m	°C	Mean water temperature $\frac{t_1 + t_2}{2}$
ΔT	K	Temperature difference t _m - t _r
Φ	W=(J/s)	Heat capacity
Φ _S	W	Nominal heat emission
Φ _L	W	Nominal heat emission per module
c _p	J/kg K	Mean specific heat capacity
n	-	Radiator characteristic, exponent
s _k	%	Percentage of emission by radiation
c _K	-	Correction factor to Φ _S
q _m	kg/h/(kg/s)	Water flow
q _{ms}	kg/h/(kg/s)	Normal water flow
v	m/s	Speed
Δp	kPa	Pressure loss, pressure drop
ζ	-	Coefficient of resistance

General

Technical details such as dimensions, weights, heat surfaces always relate to the standard model of the specific product. This information is applicable only to radiators with an overall length of 1000 mm. For other lengths, the influence of the couplings and/or header tubes must be taken into consideration.

The heat emission figures are valid for connections on the same end. The influence of other connection types is described in the technical literature. We will be pleased to provide you with information regarding specific cases.



On the 1st January 1998, the new European standards EN 442-1 to 442-3 came into force as Swiss standards SIA 384.501, SIA 384.502 and SIA 384.503. This recommendation was accepted by most of the European countries including Switzerland.

It prescribes the test procedures and measuring methods to be followed in similarly equipped test laboratories. Thus, one single measuring procedure, valid for the whole of Europe, has replaced the measuring methods, which varied from country to country hitherto.

Heat capacity Φ

The heat emission of a radiator model is determined from the nominal characteristics:

$$\Phi = K_M \cdot \Delta T^n \quad \text{where } K_M \text{ is the constant for the model.}$$

According to the new standard SIA 384.502 (EN442-2), the temperature difference is calculated from the arithmetic mean between the flow and return temperatures and the reference air temperature.

$$\Delta T = \frac{t_1 + t_2}{2} - t_r$$

Temperature difference ΔT

The heat emission for temperature differences ΔT other than the nominal temperature difference ΔT = 50 K can therefore be calculated from the equation

$$\Phi = \Phi_S \left(\frac{\Delta T}{50K} \right)^n$$

Example of the heat emission calculation for Φ

- Φ_S = 459 W
- Exponent n = 1.24
- t₁ = 60 °C
- t₂ = 40 °C
- t_r = 15 °C

$$\Delta T = \frac{60^\circ\text{C} + 40^\circ\text{C}}{2} - 15^\circ\text{C} = 35\text{K}$$

$$\Phi = 459 \text{ W} \left(\frac{35\text{K}}{50\text{K}} \right)^{1.24} = 459 \text{ W} \cdot 0.6426 = 295 \text{ W}$$

Nominal water flow q_{ms}

(heating medium flow, flow-through quantity, mass flow)

The nominal water flow q_{ms} of a radiator results in a temperature spread of 10K with a flow temperature of 75 °C (nominal heat emission conditions).

$$\text{Therefore } q_{ms} = \frac{\Phi}{c_p(t_1 - t_2)} \quad c_p \approx 4187 \frac{\text{J}}{\text{kg}\cdot\text{K}}$$

The actual water flow q_m of a radiator can differ considerably from the nominal water flow q_{ms} with flow and return temperatures other than 75/65 °C.

Case 1:

Runtal Jet
 $\Phi_s = 459 \text{ W}$
 Model RH42-1000
 Temperatrues: 75/65/20 °C

$$q_{ms} = \frac{459}{4187(75 - 65)} \quad q_{ms} = 0.011 \text{ kg/s} \approx 39.5 \text{ kg/h}$$

Case 2:

Runtal Jet
 $\Phi_s = 239 \text{ W}$
 Model RH42-1000
 Temperatrues: 55/40/18 °C

$$q_{ms} = \frac{239}{4187(55 - 40)} \quad q_{ms} = 0.0038 \text{ kg/s} \approx 13.7 \text{ kg/h}$$

The actual water flow q_m as a % of q_{ms} in Case 2 is therefore :

$$\frac{q_m}{q_{ms}} \text{ as a \%}$$

$$\frac{13.7}{39.5} \text{ as a \%}$$

q_m is therefore 35% q_{ms}

The minimum according to the table is 20%.
 Case 2 fulfils the minimum water flow requirements.

Minimum water flow $q_{m \text{ min.}}$

The series of measurements that we have carried out has indicated that individual radiators react differently to deviations in the nominal water flow q_{ms} and that, for water flows below certain minimum water flows $q_{m \text{ min.}}$, it is difficult to make reliable statements about the heat emission. With constructional measures, operation with smaller water flows q_m is often made possible.

We will be pleased to be of assistance in specific cases; critical applications can be tested in our laboratory. The following table indicates the minimum water flows q_m as a % of the nominal water flows q_{ms} , which under normal circumstances should not be lessened:

Radiators	q_m as % of q_{ms}
- runtal jet panel radiator (horizontal model)	20 %
- runtal jet panel radiator (vertical model)	17 %
- Multicolumn zehnder multicolumn	17 %
- runtal RX flat-oval radiator	17 %
- zehnder radiavector	30 %

Bathroom radiators	q_m as % of q_{ms}
zehnder universal, toga	27 %

Models 211-214

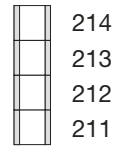
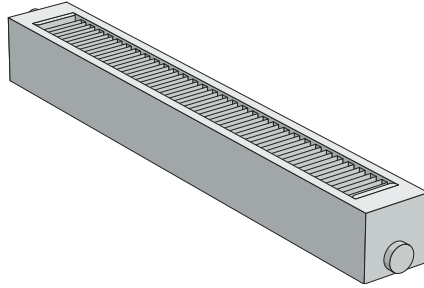

Models 221-224

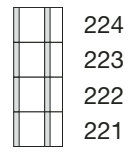
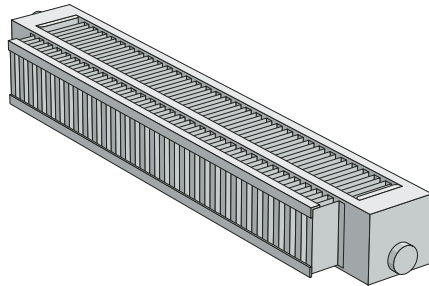

Models 321-324

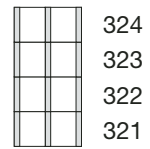
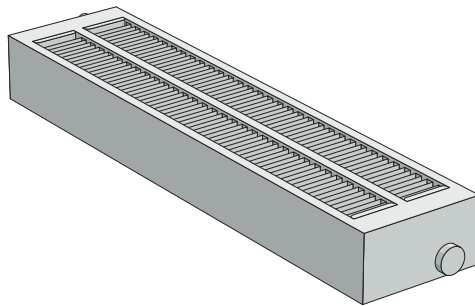

Models 431-434

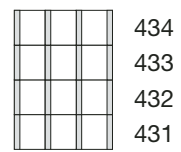
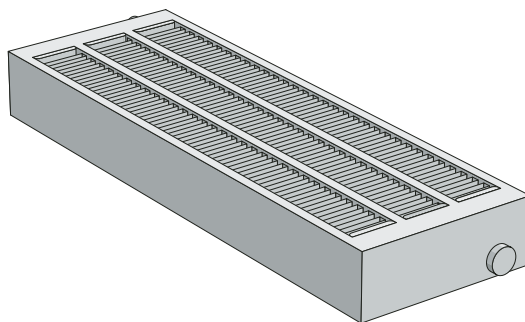

Models 541-544

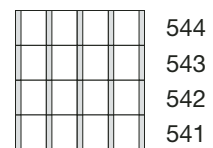
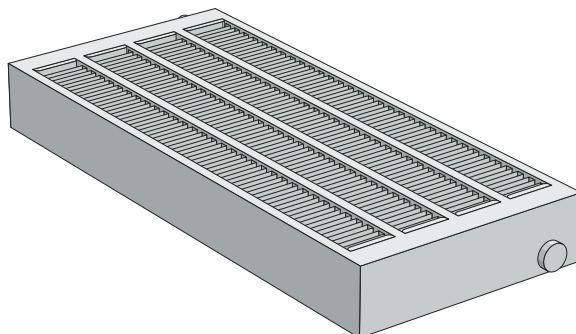

zehnder *radiavector*

General

The **zehnder radiavector** consists of all-welded precision steel tubing.

Materials used

Flat tubing	70 x 11 mm
Headers	3–6 mm according to type
Fins	Sheet steel 0.5 mm thick

Special features

- Low overall height
- Modern styling
- Wide range of models
- no sharp edges or corners
- high heat capacity
- the fins are located between the water channels, thus virtually precluding damage and risk of physical injury
- easy to clean
- suitable for low temperature systems

Application

The **zehnder radiavector** can be used in all types of buildings. Particularly suitable when there is little space, for example with low window sills and for installations in floor ducts when the heating demand is high. Often installed in front of windows. Thanks to its solid construction, the **zehnder radiavector** can also be placed in public areas and halls.

Dimensions

Overall lengths	500 to 6000 mm (in 100 mm increments)
Overall heights	70 to 280 mm

Intermediate lengths and overlengths up to 7000 mm can be supplied to order.

An average length tolerance of ± 2 mm per metre run must be allowed for.

Important: remember transport limitations!

The British Standard Code of Practice BS7593: 1992 Treatment of Water in Hot Water Central Heating Systems, should be observed when installing a system.

All Zehnder products are supplied with a 2 year warranty on materials and manufacture. However, this may be invalidated should adequate water treatment not be applied during installation and throughout the life of the system.

Test pressure

Standard	6.5 bar
High pressure	13.0 bar

Operating pressure (EN 442)

Standard	max. 5.0 bar
High pressure	max. 10.0 bar

Operating temperature

max. 120°C

Basic delivery schedule for standard delivery

Supplied ready-to-install with 2, 3 or 4 end-connectors for flow, return, venting and draining. Stove-enamelled in RAL 9016 standard colour tone, with transport packaging (plastic film and edge protectors).

Special versions (price supplement)

- Galvanized version
 - Angled configuration
 - Intermediate lengths and lengths between 6000–7000 mm
 - High pressure
 - Special connections for 2 pipe systems
 - Non-removable cover grid
 - Bench version
 - Completto version
 - Version with special feet
 - Models weighing over 400 kg
- Further special versions on demand

Stove-enamelling

Standard version RAL 9016 pure white

Special enamelling (price supplement)

- In Zehnder colour range; Z-Collection
- In other RAL, NCS-S and sanitary ware colours

Slight colour differences versus the original RAL or NCS colours are possible, due to varying glazes and other production processes.

Galvanized version

- All models can be galvanized
- Minimum connection size: 1/2"
- Opposite end connections: min. 3 x 1/2"
- Same end connections: min. 4 x 1/2"
- Radiavectors with one-pipe connections cannot be galvanized
- Inner corrosion inhibition not guaranteed
- Overpainting is not recommended (surface structure)

Models 211–544

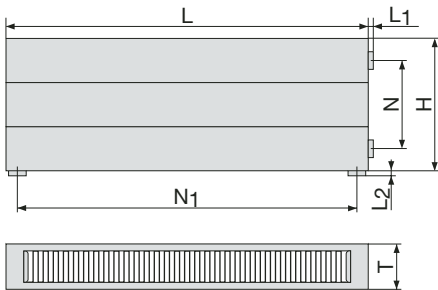

- H = overall height [mm]
- L = overall length [mm]
- T = overall depth [mm]
- N, N₁ = connection spacing [mm]*
- L₁, L₂ = connection boss length [mm]*
- A = surface area [m²]
- V = water content [dm³]
- M = weight [kg]
- s_k = radiation percentage [%]
- q_{ms} = rated water flow [kg/h]
- n = exponent

* see page 10

Technical data overall length 1000 mm

Model	H mm	T mm	N mm	A m ²	V dm ³	M kg	s _k %	q _{ms} kg/h	Exp. n	Φ _L =ΔT 50 K EN 442 Watt
211	70	73	34	1.08	1.20	5.70	13	32	1.26	369
221	70	103	34	1.61	1.20	6.80	13	40	1.28	460
321	70	134	34	2.00	1.90	9.45	12	54	1.30	628
431	70	196	34	2.92	2.60	13.30	11	72	1.32	837
541	70	257	34	3.84	3.25	17.05	11	93	1.31	1077
212	140	73	104	2.18	2.40	11.50	14	45	1.30	528
222	140	103	104	3.29	2.40	13.70	12	56	1.32	651
322	140	134	104	4.07	3.80	19.10	10	79	1.32	915
432	140	196	104	5.94	5.20	26.85	9	108	1.33	1256
542	140	257	104	7.82	6.50	34.50	8	143	1.31	1660
213	210	73	174	3.28	3.60	17.25	14	59	1.33	689
223	210	103	174	4.96	3.60	20.65	12	73	1.36	850
323	210	134	174	6.13	5.70	28.70	10	101	1.33	1172
433	210	196	174	8.97	7.80	40.35	8	140	1.35	1625
543	210	257	174	11.80	9.75	51.90	8	185	1.31	2148
214	280	73	244	4.39	4.80	23.00	14	74	1.37	865
224	280	103	244	6.64	4.80	27.45	12	93	1.40	1076
324	280	134	244	8.19	7.60	38.30	10	123	1.35	1425
434	280	196	244	11.98	10.40	53.90	8	170	1.36	1979
544	280	257	244	15.78	13.00	69.35	7	222	1.31	2587

zehnder radiavector



Minimum water flow $q_{m \text{ min}}$

The rated water flow q_{ms} for each model is given in the technical data tables. The effective water flow q_m through the **zehnder radiavector** should not normally be less than 30% of the rated water flow.

Pressure drop Δp (connection resistance incl.)

The pressure drop Δp of a **zehnder radiavector** as a function of connection size and water flow q_m [kg/h] is obtained from the graph.

Models 211-544

Connection sizes $\frac{3}{8}$ ", $\frac{1}{2}$ ", $\frac{3}{4}$ "

Same end connection, opposite end connections or vertical entry connections positions.

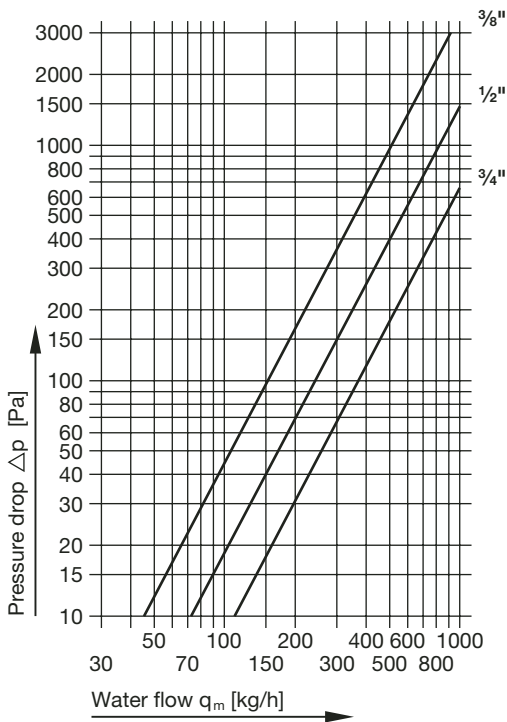

Radiavector RV-completo

Connection sizes $\frac{1}{2}$ "
50 mm distance

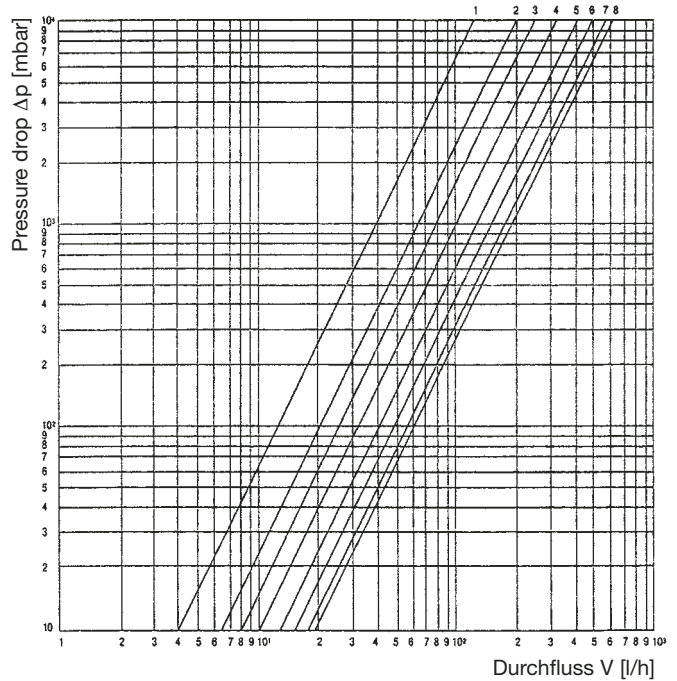

VE	1	2	3	4	5	6	7	8
kv	0.125	0.200	0.250	0.320	0.410	0.490	0.575	0.620

Radiavectors connected in series

The total pressure drop through series-connected *Radiavectors* consists of:

Individual Radiavector pressure drop (see graph):

- $q_m \textcircled{1} = 100\%$ of total battery water flow
- $q_m \textcircled{2} = 50\%$ of total battery water flow

Pressure drop of link pipes:

- $q_m \textcircled{3} = 100\%$ of total battery water flow
- $q_m \textcircled{4} = 50\%$ of total battery water flow

Same-end connections

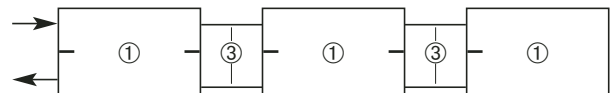

Opposite-end connections



Location of connections

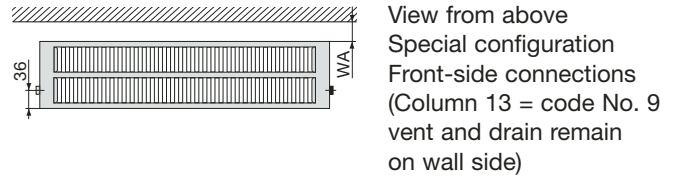
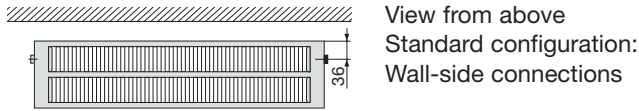

Single entry connection systems

On request, the factory provides connections compatible with all commercially available special valves for single entry systems. The operational integrity of each model is guaranteed only up to a specified overall length.

Maximum overall length on request. Overlengths require two connections (code n° 63). Technical data concerning the operation of the **zehnder radiavector** with various valve types supplied on request

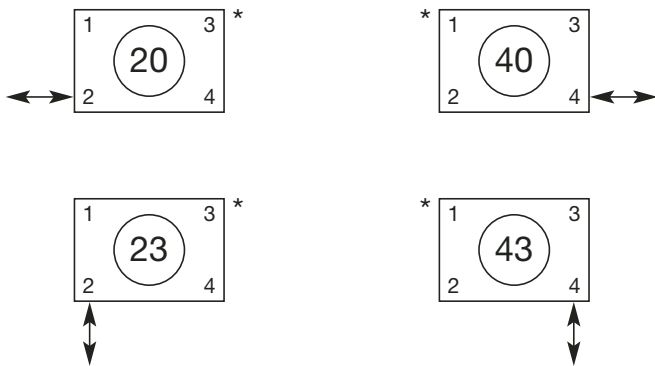

Model	Max. overall length mm with one connection
321	2500
322	3600
323	3800
324	4000
431	2500
432	3600
433	3400
434	3400
541	2500
542	3600
543	3200
544	3000

Two-pipe systems connections

Only 3/8" and 1/2" connections are possible on the same end of the **zehnder radiavector** with an overall height of 70 mm.

Standard connections 3/8", 1/2" and 3/4"

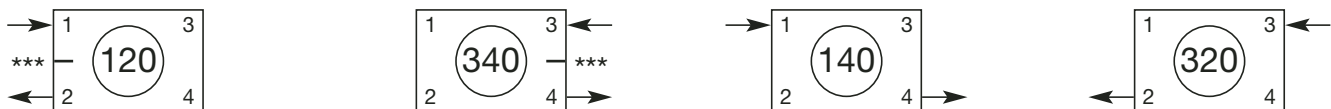

Special connection 3/8", 1/2" and 3/4" (price supplement)

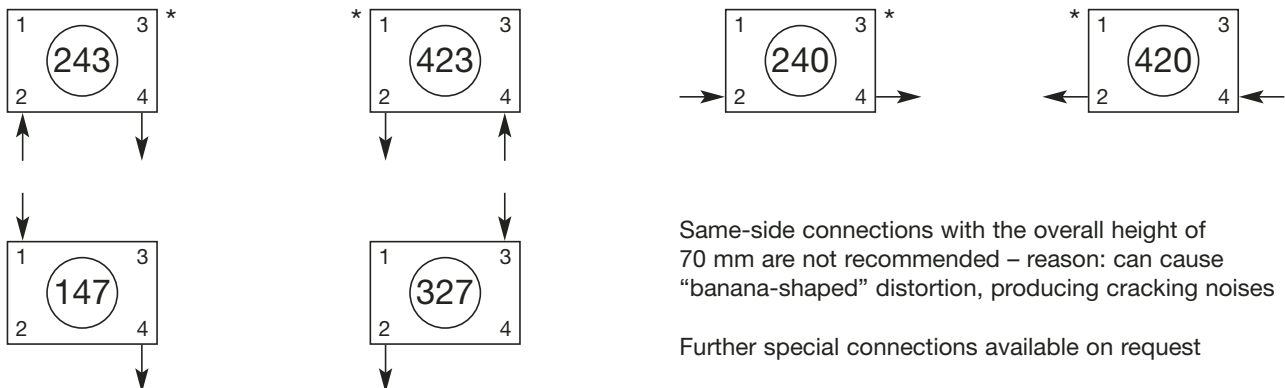

Same-side connections with the overall height of 70 mm are not recommended – reason: can cause “banana-shaped” distortion, producing cracking noises

Further special connections available on request

* Vent mandatory 1/4", 3/8" or 1/2" (standard 1/4")

Basic observation

Technically, series-connected radiators can be regarded as a single radiator.

Link piping

The flow resistance of the link pipes between the individual radiators in the series must not be excessive. These should be at least one size larger than the flow connection. The recommended connection size is 3/4".

Same-end connections

The maximum overall length of the entire series-mounted installation of **zehnder radiavectors** is limited to 18 metres (comprising a maximum of 3 radiator units).

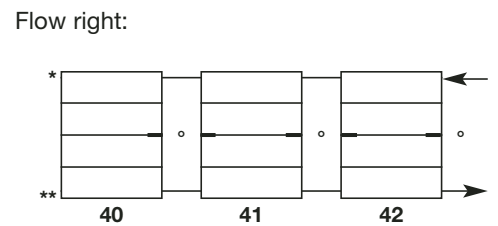
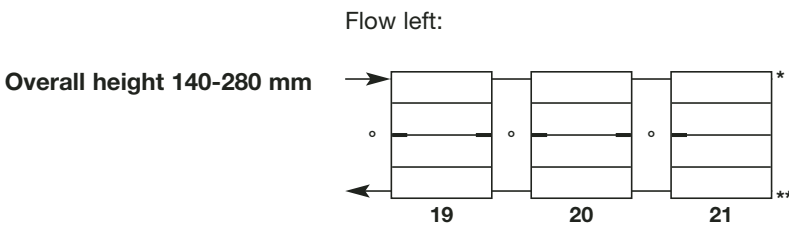

Opposite-end connections

The maximum overall length of the entire series-connected installation is limited to 18 metres (comprising a maximum of 3 radiator units)

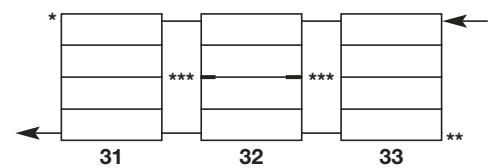
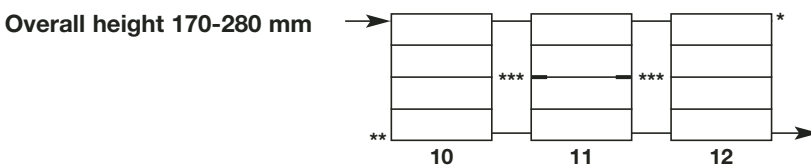
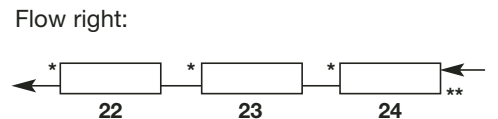
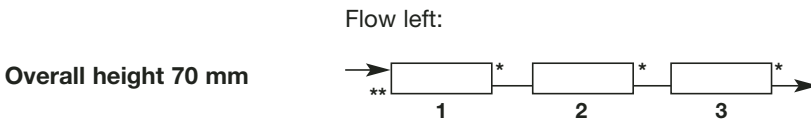

Vertical connections

The maximum overall length of the entire series-connected installation is limited to 10 metres (comprising a maximum of 3 radiator units)

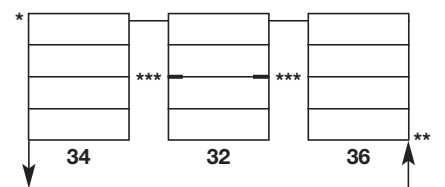
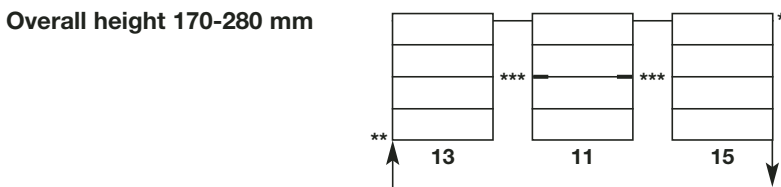

- * Bleed valve obligatory
- ** Drain lock obligatory
- *** Baffle
- ° Baffle 100% watertight

For vertical connections

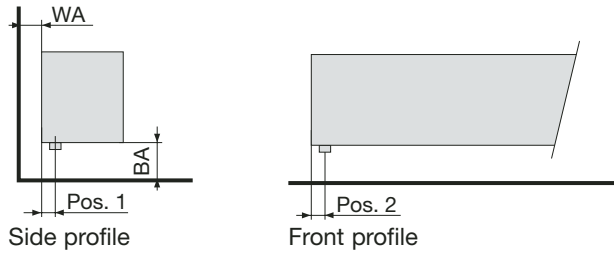

For end connections

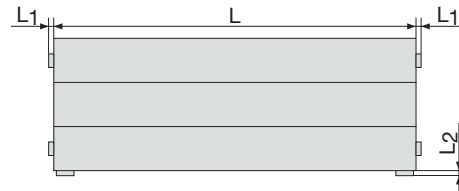

Connection dimensions in mm

Model	Pos. 1 3/8", 1/2", 3/4"	Pos. 2 3/8", 1/2", 3/4"
211, 212, 213, 214	36mm	17mm
321, 322, 323, 324		
431, 432, 433, 434		
541, 542, 543, 544	67mm	
221, 222, 223, 224		

End profiles

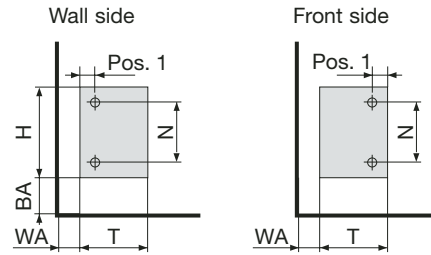

N = H-36 for 3/8" and 1/2" connections.
N = H-52 for 3/4" connections

Recommended minimum clearances

Model	Height above floor BA min. mm
211 221	40
212 222	50
213 223 321	60
214 224 322	70
	323 80
	324 90
	431 324 100
	432 110
	433 120
	434 541 130
	542 140
	543 150
	544

Dimensions of connection bosses

Connection Location	L ₁ , L ₂ = connection bosses mm			
	1/4"	3/8"	1/2"	3/4"
ends	2	2	2	2
bottom	10	13	16	17

High pressure version

Connection dimension N applies to 6.5-bar standard version only. Dimensions for high pressure version on request.

In general, the minimum distance from the back of the radiator to the wall should be 20mm.
Models 221 to 224 can have a minimum distance of 10mm.

- H = Overall height [mm]
- L = Overall length [mm]
- T = Overall depth [mm]
- N, N₁ = Connector spacing [mm]*
- L₁, L₂ = Connection boss length [mm]*
- WA = Distance from wall [mm]
- BA = Height above floor [mm]

Support and suspension axes

	Model					Model	
	211	221	321	431	541	433	542
	212	222	322	432		434	543
	213	223	323				544
	214	224	324				
				to 1600 mm		to 1200 mm	
				from 1700 mm to 3200 mm		from 1300 mm to 2400 mm	
				from 3300 mm to 4800 mm		from 2500 mm to 3600 mm	
				from 4900 mm to 6000 mm		from 3700 mm to 4800 mm	
						from 4900 mm to 6000 mm	

Standard configuration **without** suspension bracket

Models 321, 431, 541 544 must be mounted on support legs only.

Radiavectors can be supplied with rear-mounted suspension brackets or suspension plates on request. Order form column 9 = code No. 1 (price supplement).

Standard configuration **without** suspension bracket

Radiavectors can be supplied with rear-mounted suspension brackets or suspension plates on request. Order form column 9 = code No. 1 (price supplement).

Suspension brackets for models 213, 214, 323, 324
Not available for other models

Suspension plates for models 223 to 224
Note: The fins are not recessed on these models.

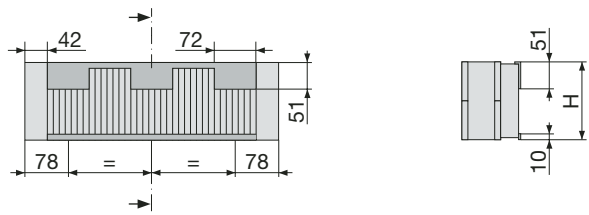
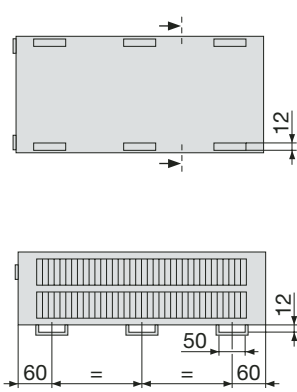

L = Radiavector length [mm]
H = Overall height [mm]

Dimensions from wall, when using CVD wall supports with standard end connections

Type	Bracket Type and slot position	Back face to finished wall	Conn centres from finished wall	Front face from finished wall
213, 214	cvd-1 25 mm slot	37	74	110
	cvd-1 30 mm slot	42	79	115
223, 224	cvd-0 10 mm slot	10	77	113
	cvd-0 15 mm slot	15	82	118
	cvd-1 25 mm slot	25	92	128
	cvd-1 30 mm slot	30	97	133
323, 324	cvd-1 25 mm slot	37	74	171
	cvd-1 30 mm slot	42	79	176

CVD-0

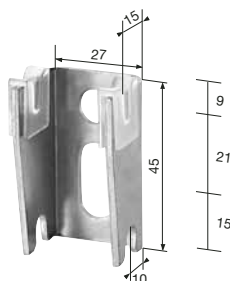

CVD-1

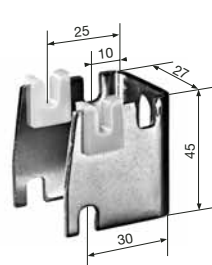

Floor supports

For **zehnder radiavector**

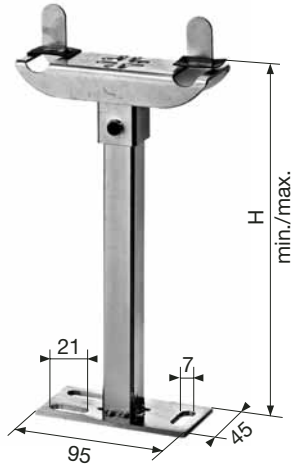

Foot support EFK-1/EFK-2/EFK-3

Application: Suitable for floor support, composed of adjustable upright stand WBT and horizontal support U-1/U-2/U-3. Base plate 95 x 45 mm. Fitted with anti-friction/noise cushions.

Height H		211-214, 221-224		321-324, 541-544		421-434	
min. mm	max. mm	Type	Article No.	Type	Article No.	Type	Article No.
51	71	EFK 1- 45	752111	EFK 2- 45	752211	EFK 3- 45	752311
69	90	EFK 1- 65	750111	EFK 2- 65	750211	EFK 3- 65	750311
89	111	EFK 1- 85	750121	EFK 2- 85	750121	EFK 3- 85	750321
104	126	EFK 1-100	750131	EFK 2-100	750231	EFK 3-100	750331
119	141	EFK 1-115	750141	EFK 2-115	750241	EFK 3-115	750341
134	156	EFK 1-130	750151	EFK 2-130	750251	EFK 3-130	750351
150	172	EFK 1-146	750161	EFK 2-146	750261	EFK 3-146	750361
165	187	EFK 1-161	752121	EFK 2-161	752221	EFK 3-161	752321
180	202	EFK 1-176	750171	EFK 2-176	750271	EFK 3-176	750371
194	216	EFK 1-190	752131	EFK 2-190	752231	EFK 3-190	752331
212	234	EFK 1-208	750181	EFK 2-208	750281	EFK 3-208	750381
227	249	EFK 1-223	752141	EFK 2-223	752241	EFK 3-223	752341
242	264	EFK 1-238	750191	EFK 2-238	750291	EFK 3-238	750391
273	295	EFK 1-269	752151	EFK 2-269	752251	EFK 3-269	752351
288	310	EFK 1-284	752161	EFK 2-284	752261	EFK 3-284	752361
303	325	EFK 1-299	752171	EFK 2-299	752271	EFK 3-299	752371
454	476	EFK 1-450	752191	EFK 2-450	752291	EFK 3-450	752391

Wall supports

For **zehnder radiavector**

Wall support WAK

Application: Adjustable screw on type suitable for wall support, composed of WBT and EH for horizontal support. Wall plate 95 x 45 mm. Fitted with anti-friction/noise cushions.

Type	Model	Length mm	Distance/ wall mm	RAL 9016	Special colour	Zinc
				Article No.	Article No.	Article No.
WAK 1-089	<i>radiavector</i>	89	20	782121	782129	782122
WAK 1-104	Types	104	35	782141	782149	782142
WAK 1-119	211-214	119	50	782131	782139	782132
WAK 1-119	<i>radiavector</i>	119	20	782131	782139	782132
WAK1-134	Types	134	35	782151	782159	782152
WAK 1-150	321-324	150	50	782161	782169	782162
WAK 2-150	<i>radiavector</i>	150	20	782261	782269	782262
WAK 2-165	Types	165	35	782281	782289	782282
WAK 2-180	321-324	180	50	782271	782279	782272
WAK 3-212	<i>radiavector</i>	212	20	782381	782389	782382
WAK 3-227	Type 431	227	35	782371	782379	782372
WAK 3-242		242	50	782391	782399	782392

For reasons of stability, the WAK should not be used with models 432-434, 541-544. It is recommended that floor supports be used instead of wall supports.

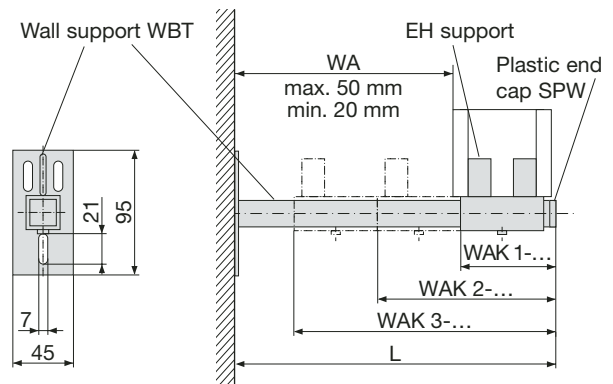

Security clips and cover plates

For **zehnder radiavector**



Security clip RF

Application: For use with the **zehnder radiavector** with the EFK floor supports. The use of the clips is particularly recommended for radiavectors with same end or single entry connections. Supplied only on request at additional cost.

Type	Radiavector height mm	RAL 9016	Special colour	Zinc
		Article No.	Article No.	Article No.
RF-70	70	793011	793019	793012
RF-140	140	793021	793029	793022
RF-210	210	793031	793039	793032
RF-280	280	793041	793049	793042



Security clip RW

Application: For use with the **zehnder radiavector** with the WAK wall supports. The use of the clips is particularly recommended for radiavectors with same end or single entry connections. Supplied only on request at additional cost.

Type	Radiavector height mm	RAL 9016	Special colour	Zinc
		Article No.	Article No.	Article No.
RW-70	70	794011	794019	794012
RW-140	140	794021	794029	794022
RW-210	210	794031	794039	794032
RW-280	280	794041	794049	794042



Cover plate AD (synthetic material)

Application: For use with EFK or WAK radiavectors. Cover plate type ADZ can be fitted after installation.

Type	Number of pieces	Finish	Article No.
ADZ	2 pieces	white	753020
ADE	1 piece	grey	753010
ADZ	2 pieces	painting	753029
ADE	1 piece	painting	753019

The installation of the **zehnder radiavector**, when the heat emission equals the heat loss of the glazing:

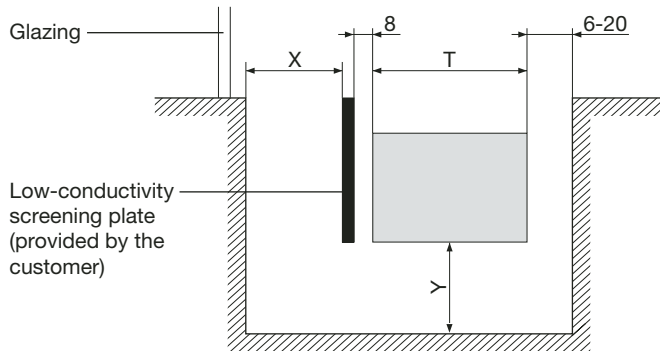

Arrangement in floor duct

The heat emission of radiavectors installed in a floor duct is reduced by **20%**. The reduction is even greater if the radiavectors are covered by a customer-provided floor grille. A grating with a blockage factor of **30%** would give a total heat reduction of **35%**.

Please supply accurately dimensioned drawings (section, elevation, etc) if you wish to consult us regarding any particular installation.

Correction factors c_k for radiavectors models 323, 324, 433, 434, 543, 544 in mixed systems

We recommend that the above models of radiavectors in a mixed system that includes tube or panel radiators be dimensioned to provide a heat emission increase of **10%**.

The installation of **zehnder radiavectors**, when the heat emission is greater than the heat loss of the glazing:

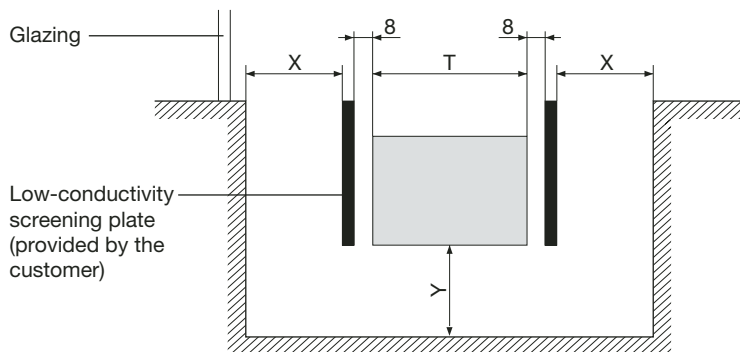

Dimension X = dimension Y = Overall depth T
Dimensions in mm



RV-Completo – technical

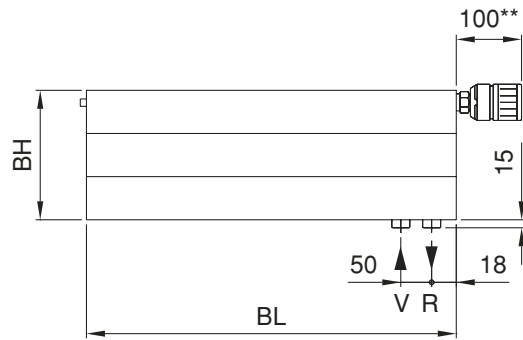

Illustrated: Connections on right hand side. Please indicate the required position of the connection on the right of left when orderin.

BH = Height

BL = Length

** Valid for Zehnder LH Thermostatic heads.

Standard manufacture includes

- Painted to RAL 9016 finish
- Integrated valve body
- Zehnder thermostatic head
- 2 x 1/2" connections, 50 mm distances
- 1/2" air vent connection
- 5 bar maximum operating pressure
- 120 °C maximum operating temperature

Special control valve

A special control valve is built in to the Radiavector at the time of manufacture. The valve can be pre-adjusted.

The M30 x 1.5 mm connection thread of the thermostatic head allows it to be used in conjunction with other commercially available thermostatic heads.

Recommended max. flo rate for the valve ist 250 kg/h.

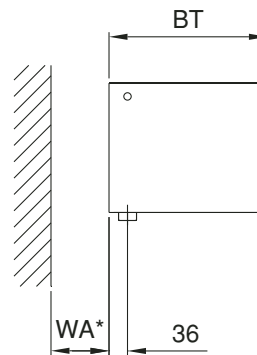

BT = Depth

WA = Distance to wall

* The distance to the wall, and distance from the wall to the centre of connections depends on the type of mounting selected. (See pg. 13).

Special configurations

zehnder radiavector

zehnder

A large number of special configurations are available on request. Please call us – we shall be pleased to advise you.

Angled configuration

Radiators with a maximum of 3 or 4 angles are available. Please include a dimensioned drawing with your order.

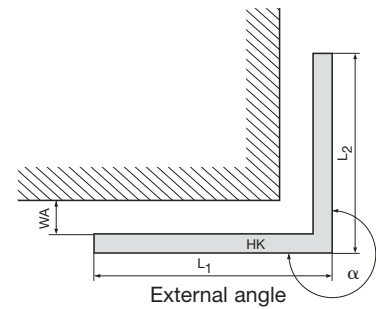
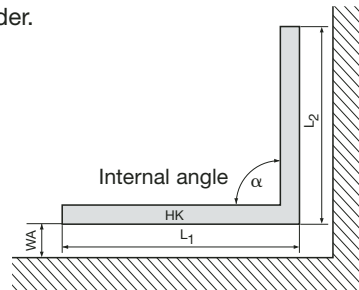

- HK = Radiator
- WA = Distance from wall [mm]
- α = Wall angle [°]
- L_1, L_2 = Lengths [mm]

Bench version



Special support legs



Grille design

Made of 4 mm dia. round steel tubing.
Permanently welded, painted same colour as radiator.
Minimal heat-emission reduction.
Aesthetic and elegant design for **zehnder radiavector**.

Overall height = 70 mm $\Phi_L = \Delta T 50 K EN 442$ (SN 384.501-503)

Mod.		211			221			321			431			541		
T	mm	73			103			134			196			257		
H	mm	70			70			70			70			70		
Exp.	n	1.26			1.28			1.3			1.32			1.31		
Length		Watt 50	Watt 56	Watt 60	Watt 50	Watt 56	Watt 60	Watt 50	Watt 56	Watt 60	Watt 50	Watt 56	Watt 60	Watt 50	Watt 56	Watt 60
500		185	213	232	230	266	290	314	364	398	419	486	532	539	625	684
600		221	255	279	276	319	349	377	437	478	502	583	639	646	750	821
700		258	298	325	322	372	407	440	509	557	586	680	745	754	875	957
800		295	341	371	368	425	465	502	582	637	670	778	852	862	999	1094
900		332	383	418	414	479	523	565	655	716	753	875	958	969	1124	1231
1000		369	426	464	460	532	581	628	728	796	837	972	1065	1077	1249	1368
1100		406	468	511	506	585	639	691	800	876	921	1069	1171	1185	1374	1504
1200		443	511	557	552	638	697	754	873	955	1004	1166	1278	1292	1499	1641
1300		480	553	604	598	691	755	816	946	1035	1088	1264	1384	1400	1624	1778
1400		517	596	650	644	745	813	879	1019	1114	1172	1361	1491	1508	1749	1915
1500		554	638	696	690	798	871	942	1092	1194	1256	1458	1597	1616	1874	2051
1600		590	681	743	736	851	929	1005	1164	1274	1339	1555	1704	1723	1999	2188
1700		627	724	789	782	904	988	1068	1237	1353	1423	1653	1810	1831	2124	2325
1800		664	766	836	828	957	1046	1130	1310	1433	1507	1750	1917	1939	2249	2462
1900		701	809	882	874	1010	1104	1193	1383	1512	1590	1847	2023	2046	2374	2598
2000		738	851	929	920	1064	1162	1256	1455	1592	1674	1944	2129	2154	2499	2735
2200		812	936	1021	1012	1170	1278	1382	1601	1751	1841	2139	2342	2369	2749	3009
2400		886	1022	1114	1104	1276	1394	1507	1746	1910	2009	2333	2555	2585	2998	3282
2600		959	1107	1207	1196	1383	1510	1633	1892	2070	2176	2527	2768	2800	3248	3556
2800		1033	1192	1300	1288	1489	1627	1758	2038	2229	2344	2722	2981	3016	3498	3829
3000		1107	1277	1393	1380	1595	1743	1884	2183	2388	2511	2916	3194	3231	3748	4103
3200		1181	1362	1486	1472	1702	1859	2010	2329	2547	2678	3111	3407	3446	3998	4376
3400		1255	1447	1579	1564	1808	1975	2135	2474	2706	2846	3305	3620	3662	4248	4650
3600		1328	1532	1671	1656	1915	2091	2261	2620	2865	3013	3499	3833	3877	4498	4923
3800		1402	1617	1764	1748	2021	2207	2386	2765	3025	3181	3694	4046	4093	4748	5197
4000		1476	1703	1857	1840	2127	2324	2512	2911	3184	3348	3888	4259	4308	4997	5470
4200		1550	1788	1950	1932	2234	2440	2638	3056	3343	3515	4083	4472	4523	5247	5744
4400		1624	1873	2043	2024	2340	2556	2763	3202	3502	3683	4277	4685	4739	5497	6017
4600		1697	1958	2136	2116	2446	2672	2889	3347	3661	3850	4471	4898	4954	5747	6291
4800		1771	2043	2229	2208	2553	2788	3014	3493	3821	4018	4666	5111	5170	5997	6564
5000		1845	2128	2321	2300	2659	2905	3140	3638	3980	4185	4860	5324	5385	6247	6838
5200		1919	2213	2414	2392	2765	3021	3266	3784	4139	4352	5055	5537	5600	6497	7111
5400		1993	2298	2507	2484	2872	3137	3391	3929	4298	4520	5249	5750	5816	6747	7385
5600		2066	2384	2600	2576	2978	3253	3517	4075	4457	4687	5444	5963	6031	6996	7658
5800		2140	2469	2693	2668	3085	3369	3642	4221	4617	4855	5638	6176	6247	7246	7932
6000		2214	2554	2786	2760	3191	3485	3768	4366	4776	5022	5832	6388	6462	7496	8205

Overall height = 140 mm $\Phi_L = \Delta T 50 K EN 442$ (SN 384.501-503)

Mod.		212			222			322			432			542		
T	mm	73			103			134			196			257		
H	mm	140			140			140			140			140		
Exp.	n	1.3			1.32			1.32			1.33			1.31		
Length		Watt 50	Watt 56	Watt 60	Watt 50	Watt 56	Watt 60	Watt 50	Watt 56	Watt 60	Watt 50	Watt 56	Watt 60	Watt 50	Watt 56	Watt 60
500		264	306	335	326	378	414	458	531	582	628	730	800	830	963	1054
600		317	367	402	391	454	497	549	638	698	754	876	960	996	1155	1265
700		370	428	468	456	529	580	641	744	815	879	1022	1120	1162	1348	1475
800		422	489	535	521	605	663	732	850	931	1005	1168	1281	1328	1541	1686
900		475	551	602	586	680	745	824	956	1048	1130	1314	1441	1494	1733	1897
1000		528	612	669	651	756	828	915	1063	1164	1256	1460	1601	1660	1926	2108
1100		581	673	736	716	832	911	1007	1169	1280	1382	1606	1761	1826	2118	2319
1200		634	734	803	781	907	994	1098	1275	1397	1507	1752	1921	1992	2311	2529
1300		686	795	870	846	983	1077	1190	1381	1513	1633	1898	2081	2158	2503	2740
1400		739	857	937	911	1058	1159	1281	1488	1630	1758	2044	2241	2324	2696	2951
1500		792	918	1004	977	1134	1242	1373	1594	1746	1884	2190	2401	2490	2889	3162
1600		845	979	1071	1042	1210	1325	1464	1700	1862	2010	2337	2561	2656	3081	3373
1700		898	1040	1138	1107	1285	1408	1556	1806	1979	2135	2483	2721	2822	3274	3583
1800		950	1101	1205	1172	1361	1491	1647	1913	2095	2261	2629	2881	2988	3466	3794
1900		1003	1162	1272	1237	1436	1573	1739	2019	2212	2386	2775	3041	3154	3659	4005
2000		1056	1224	1338	1302	1512	1656	1830	2125	2328	2512	2921	3201	3320	3851	4216
2200		1162	1346	1472	1432	1663	1822	2013	2338	2561	2763	3213	3521	3652	4236	4637
2400		1267	1468	1606	1562	1815	1988	2196	2550	2794	3014	3505	3842	3984	4622	5059
2600		1373	1591	1740	1693	1966	2153	2379	2763	3026	3266	3797	4162	4316	5007	5480
2800		1478	1713	1874	1823	2117	2319	2562	2975	3259	3517	4089	4482	4648	5392	5902
3000		1584	1835	2008	1953	2268	2484	2745	3188	3492	3768	4381	4802	4980	5777	6323
3200		1690	1958	2142	2083	2419	2650	2928	3400	3725	4019	4673	5122	5312	6162	6745
3400		1795	2080	2275	2213	2571	2816	3111	3613	3957	4270	4965	5442	5644	6547	7167
3600		1901	2203	2409	2344	2722	2981	3294	3826	4190	4522	5257	5762	5976	6932	7588
3800		2006	2325	2543	2474	2873	3147	3477	4038	4423	4773	5549	6083	6308	7318	8010
4000		2112	2447	2677	2604	3024	3313	3660	4251	4656	5024	5841	6403	6640	7703	8431
4200		2218	2570	2811	2734	3175	3478	3843	4463	4889	5275	6133	6723	6972	8088	8853
4400		2323	2692	2945	2864	3327	3644	4026	4676	5121	5526	6425	7043	7304	8473	9274
4600		2429	2814	3078	2995	3478	3809	4209	4888	5354	5778	6717	7363	7636	8858	9696
4800		2534	2937	3212	3125	3629	3975	4392	5101	5587	6029	7010	7683	7968	9243	10118
5000		2640	3059	3346	3255	3780	4141	4575	5313	5820	6280	7302	8003	8300	9628	10539
5200		2746	3181	3480	3385	3931	4306	4758	5526	6053	6531	7594	8323	8632	10014	10961
5400		2851	3304	3614	3515	4083	4472	4941	5738	6285	6782	7886	8644	8964	10399	11382
5600		2957	3426	3748	3646	4234	4638	5124	5951	6518	7034	8178	8964	9296	10784	11804
5800		3062	3549	3881	3776	4385	4803	5307	6163	6751	7285	8470	9284	9628	11169	12225
6000		3168	3671	4015	3906	4536	4969	5490	6376	6984	7536	8762	9604	9960	11554	12647

Overall height = 210 mm $\Phi_L = \Delta T 50 K EN 442$ (SN 384.501-503)

Mod.		213			223			323			433			543		
T	mm	73			103			134			196			257		
H	mm	210			210			210			210			210		
Exp.	n	1.33			1.36			1.33			1.35			1.31		
Length		Watt 50	Watt 56	Watt 60	Watt 50	Watt 56	Watt 60	Watt 50	Watt 56	Watt 60	Watt 50	Watt 56	Watt 60	Watt 50	Watt 56	Watt 60
500		345	401	439	425	496	545	586	681	747	813	947	1039	1074	1246	1364
600		413	481	527	510	595	654	703	818	896	975	1136	1247	1289	1495	1636
700		482	561	615	595	694	762	820	954	1046	1138	1326	1455	1504	1744	1909
800		551	641	702	680	793	871	938	1090	1195	1300	1515	1663	1718	1993	2182
900		620	721	790	765	892	980	1055	1226	1344	1463	1704	1871	1933	2243	2455
1000		689	801	878	850	992	1089	1172	1363	1494	1625	1894	2078	2148	2492	2727
1100		758	881	966	935	1091	1198	1289	1499	1643	1788	2083	2286	2363	2741	3000
1200		827	961	1054	1020	1190	1307	1406	1635	1792	1950	2272	2494	2578	2990	3273
1300		896	1041	1141	1105	1289	1416	1524	1771	1942	2113	2462	2702	2792	3239	3546
1400		965	1122	1229	1190	1388	1525	1641	1908	2091	2275	2651	2910	3007	3488	3818
1500		1034	1202	1317	1275	1487	1634	1758	2044	2240	2438	2840	3118	3222	3738	4091
1600		1102	1282	1405	1360	1587	1743	1875	2180	2390	2600	3030	3326	3437	3987	4364
1700		1171	1362	1493	1445	1686	1852	1992	2317	2539	2763	3219	3533	3652	4236	4637
1800		1240	1442	1581	1530	1785	1961	2110	2453	2689	2925	3409	3741	3866	4485	4909
1900		1309	1522	1668	1615	1884	2069	2227	2589	2838	3088	3598	3949	4081	4734	5182
2000		1378	1602	1756	1700	1983	2178	2344	2725	2987	3250	3787	4157	4296	4984	5455
2200		1516	1762	1932	1870	2182	2396	2578	2998	3286	3575	4166	4573	4726	5482	6000
2400		1654	1923	2107	2040	2380	2614	2813	3270	3585	3900	4545	4988	5155	5980	6546
2600		1791	2083	2283	2210	2578	2832	3047	3543	3883	4225	4923	5404	5585	6479	7091
2800		1929	2243	2459	2380	2777	3050	3282	3815	4182	4550	5302	5820	6014	6977	7637
3000		2067	2403	2634	2550	2975	3268	3516	4088	4481	4875	5681	6235	6444	7475	8182
3200		2205	2563	2810	2720	3173	3485	3750	4361	4780	5200	6060	6651	6874	7974	8728
3400		2343	2724	2985	2890	3372	3703	3985	4633	5078	5525	6438	7067	7303	8472	9273
3600		2480	2884	3161	3060	3570	3921	4219	4906	5377	5850	6817	7483	7733	8970	9819
3800		2618	3044	3337	3230	3768	4139	4454	5178	5676	6175	7196	7898	8162	9469	10364
4000		2756	3204	3512	3400	3967	4357	4688	5451	5974	6500	7575	8314	8592	9967	10910
4200		2894	3365	3688	3570	4165	4575	4922	5723	6273	6825	7953	8730	9022	10465	11455
4400		3032	3525	3864	3740	4363	4792	5157	5996	6572	7150	8332	9145	9451	10964	12001
4600		3169	3685	4039	3910	4562	5010	5391	6268	6871	7475	8711	9561	9881	11462	12546
4800		3307	3845	4215	4080	4760	5228	5626	6541	7169	7800	9089	9977	10310	11961	13092
5000		3445	4005	4390	4250	4958	5446	5860	6813	7468	8125	9468	10392	10740	12459	13637
5200		3583	4166	4566	4420	5157	5664	6094	7086	7767	8450	9847	10808	11170	12957	14183
5400		3721	4326	4742	4590	5355	5882	6329	7358	8066	8775	10226	11224	11599	13456	14728
5600		3858	4486	4917	4760	5553	6099	6563	7631	8364	9100	10604	11640	12029	13954	15274
5800		3996	4646	5093	4930	5752	6317	6798	7903	8663	9425	10983	12055	12458	14452	15819
6000		4134	4807	5268	5100	5950	6535	7032	8176	8962	9750	11362	12471	12888	14951	16365

Overall height = 280 mm $\Phi_L = \Delta T 50 K EN 442$ (SN 384.501-503)

Mod.		214			224			324			434			544		
T	mm	73			103			134			196			257		
H	mm	280			280			280			280			280		
Exp.	n	1.37			1.4			1.35			1.36			1.31		
Length		Watt	Watt	Watt	Watt	Watt	Watt	Watt	Watt	Watt	Watt	Watt	Watt	Watt	Watt	
		50	56	60	50	56	60	50	56	60	50	56	60	50	56	60
500		433	505	555	538	631	694	713	830	911	990	1154	1268	1294	1501	1642
600		519	606	666	646	757	833	855	996	1094	1187	1385	1522	1552	1801	1971
700		606	707	777	753	883	972	998	1162	1276	1385	1616	1775	1811	2101	2299
800		692	808	888	861	1009	1111	1140	1328	1458	1583	1847	2029	2070	2401	2628
900		779	909	999	968	1135	1250	1283	1495	1640	1781	2078	2282	2328	2701	2956
1000		865	1010	1110	1076	1261	1389	1425	1661	1823	1979	2309	2536	2587	3001	3285
1100		952	1111	1221	1184	1387	1528	1568	1827	2005	2177	2540	2789	2846	3301	3613
1200		1038	1212	1333	1291	1513	1667	1710	1993	2187	2375	2771	3043	3104	3601	3942
1300		1125	1313	1444	1399	1639	1806	1853	2159	2369	2573	3001	3297	3363	3901	4270
1400		1211	1414	1555	1506	1765	1944	1995	2325	2552	2771	3232	3550	3622	4201	4599
1500		1298	1515	1666	1614	1892	2083	2138	2491	2734	2969	3463	3804	3881	4502	4927
1600		1384	1616	1777	1722	2018	2222	2280	2657	2916	3166	3694	4057	4139	4802	5256
1700		1471	1717	1888	1829	2144	2361	2423	2823	3099	3364	3925	4311	4398	5102	5584
1800		1557	1819	1999	1937	2270	2500	2565	2989	3281	3562	4156	4565	4657	5402	5913
1900		1644	1920	2110	2044	2396	2639	2708	3155	3463	3760	4387	4818	4915	5702	6241
2000		1730	2021	2221	2152	2522	2778	2850	3321	3645	3958	4618	5072	5174	6002	6570
2200		1903	2223	2443	2367	2774	3056	3135	3653	4010	4354	5079	5579	5691	6602	7227
2400		2076	2425	2665	2582	3026	3333	3420	3985	4374	4750	5541	6086	6209	7203	7884
2600		2249	2627	2887	2798	3279	3611	3705	4318	4739	5145	6003	6593	6726	7803	8541
2800		2422	2829	3109	3013	3531	3889	3990	4650	5103	5541	6465	7101	7244	8403	9198
3000		2595	3031	3331	3228	3783	4167	4275	4982	5468	5937	6926	7608	7761	9003	9855
3200		2768	3233	3553	3443	4035	4444	4560	5314	5833	6333	7388	8115	8278	9603	10512
3400		2941	3435	3775	3658	4287	4722	4845	5646	6197	6729	7850	8622	8796	10204	11169
3600		3114	3637	3998	3874	4540	5000	5130	5978	6562	7124	8312	9129	9313	10804	11826
3800		3287	3839	4220	4089	4792	5278	5415	6310	6926	7520	8773	9636	9831	11404	12483
4000		3460	4041	4442	4304	5044	5556	5700	6642	7291	7916	9235	10144	10348	12004	13140
4200		3633	4243	4664	4519	5296	5833	5985	6974	7655	8312	9697	10651	10865	12604	13797
4400		3806	4445	4886	4734	5548	6111	6270	7307	8020	8708	10159	11158	11383	13205	14454
4600		3979	4647	5108	4950	5801	6389	6555	7639	8384	9103	10620	11665	11900	13805	15111
4800		4152	4849	5330	5165	6053	6667	6840	7971	8749	9499	11082	12172	12418	14405	15768
5000		4325	5051	5552	5380	6305	6944	7125	8303	9113	9895	11544	12680	12935	15005	16425
5200		4498	5253	5774	5595	6557	7222	7410	8635	9478	10291	12006	13187	13452	15605	17082
5400		4671	5456	5996	5810	6809	7500	7695	8967	9842	10687	12467	13694	13970	16206	17739
5600		4844	5658	6218	6026	7062	7778	7980	9299	10207	11082	12929	14201	14487	16806	18396
5800		5017	5860	6441	6241	7314	8056	8265	9631	10572	11478	13391	14708	15005	17406	19052
6000		5190	6062	6663	6456	7566	8333	8550	9963	10936	11874	13853	15215	15522	18006	19709

Special configuration examples

zehnder *radiavector*

zehnder



Conversion factors f_i for ΔT temperature differences other than 50 K (EN 442)

$$f_i = \left(\frac{\Delta T}{50}\right)^n$$

ΔT K \ n	1,16	1,17	1,18	1,19	1,20	1,21	1,22	1,23	1,24	1,25	1,26	1,27	1,28	1,29	1,30
10	0,1546	0,1521	0,1497	0,1473	0,1450	0,1426	0,1404	0,1381	0,1359	0,1337	0,1316	0,1295	0,1274	0,1254	0,1234
11	0,1727	0,1701	0,1675	0,1650	0,1625	0,1601	0,1577	0,1553	0,1530	0,1507	0,1484	0,1462	0,1440	0,1418	0,1397
12	0,1910	0,1883	0,1856	0,1830	0,1804	0,1779	0,1753	0,1728	0,1704	0,1680	0,1656	0,1633	0,1609	0,1587	0,1564
13	0,2096	0,2068	0,2040	0,2013	0,1986	0,1959	0,1933	0,1907	0,1882	0,1857	0,1832	0,1807	0,1783	0,1759	0,1736
14	0,2284	0,2255	0,2227	0,2198	0,2171	0,2143	0,2116	0,2089	0,2063	0,2037	0,2011	0,1986	0,1960	0,1936	0,1911
15	0,2474	0,2445	0,2415	0,2387	0,2358	0,2330	0,2302	0,2274	0,2247	0,2220	0,2194	0,2167	0,2141	0,2116	0,2091
16	0,2667	0,2636	0,2607	0,2577	0,2548	0,2519	0,2490	0,2462	0,2434	0,2407	0,2380	0,2353	0,2326	0,2300	0,2274
17	0,2861	0,2830	0,2800	0,2770	0,2740	0,2711	0,2682	0,2653	0,2624	0,2596	0,2568	0,2541	0,2514	0,2487	0,2460
18	0,3057	0,3026	0,2995	0,2965	0,2935	0,2905	0,2875	0,2846	0,2817	0,2789	0,2760	0,2732	0,2704	0,2677	0,2650
19	0,3255	0,3224	0,3193	0,3162	0,3131	0,3101	0,3071	0,3042	0,3013	0,2984	0,2955	0,2926	0,2898	0,2870	0,2843
20	0,3455	0,3423	0,3392	0,3361	0,3330	0,3300	0,3270	0,3240	0,3210	0,3181	0,3152	0,3123	0,3095	0,3067	0,3039
21	0,3656	0,3624	0,3593	0,3562	0,3531	0,3501	0,3470	0,3440	0,3411	0,3381	0,3352	0,3323	0,3294	0,3266	0,3238
22	0,3858	0,3827	0,3796	0,3765	0,3734	0,3703	0,3673	0,3643	0,3613	0,3584	0,3554	0,3525	0,3496	0,3468	0,3439
23	0,4063	0,4031	0,4000	0,3969	0,3938	0,3908	0,3878	0,3848	0,3818	0,3788	0,3759	0,3730	0,3701	0,3672	0,3644
24	0,4268	0,4237	0,4206	0,4175	0,4145	0,4114	0,4084	0,4054	0,4025	0,3995	0,3966	0,3937	0,3908	0,3880	0,3851
25	0,4475	0,4444	0,4414	0,4383	0,4353	0,4323	0,4293	0,4263	0,4234	0,4204	0,4175	0,4147	0,4118	0,4090	0,4061
26	0,4683	0,4653	0,4623	0,4592	0,4563	0,4533	0,4503	0,4474	0,4445	0,4416	0,4387	0,4358	0,4330	0,4302	0,4274
27	0,4893	0,4863	0,4833	0,4803	0,4774	0,4745	0,4715	0,4686	0,4658	0,4629	0,4601	0,4572	0,4544	0,4516	0,4489
28	0,5104	0,5074	0,5045	0,5016	0,4987	0,4958	0,4929	0,4901	0,4873	0,4844	0,4816	0,4788	0,4761	0,4733	0,4706
29	0,5316	0,5287	0,5258	0,5230	0,5201	0,5173	0,5145	0,5117	0,5089	0,5062	0,5034	0,5007	0,4980	0,4952	0,4926
30	0,5529	0,5501	0,5473	0,5445	0,5417	0,5390	0,5362	0,5335	0,5308	0,5281	0,5254	0,5227	0,5200	0,5174	0,5148
31	0,5743	0,5716	0,5689	0,5662	0,5635	0,5608	0,5581	0,5554	0,5528	0,5502	0,5475	0,5449	0,5423	0,5397	0,5372
32	0,5959	0,5932	0,5906	0,5880	0,5854	0,5827	0,5801	0,5776	0,5750	0,5724	0,5699	0,5673	0,5648	0,5623	0,5598
33	0,6175	0,6150	0,6124	0,6099	0,6074	0,6049	0,6023	0,5998	0,5974	0,5949	0,5924	0,5900	0,5875	0,5851	0,5826
34	0,6393	0,6368	0,6344	0,6320	0,6295	0,6271	0,6247	0,6223	0,6199	0,6175	0,6151	0,6128	0,6104	0,6080	0,6057
35	0,6612	0,6588	0,6565	0,6541	0,6518	0,6495	0,6472	0,6449	0,6426	0,6403	0,6380	0,6357	0,6335	0,6312	0,6290
36	0,6831	0,6809	0,6787	0,6764	0,6742	0,6720	0,6698	0,6676	0,6654	0,6632	0,6611	0,6589	0,6567	0,6546	0,6524
37	0,7052	0,7031	0,7010	0,6989	0,6968	0,6947	0,6926	0,6905	0,6884	0,6863	0,6843	0,6822	0,6802	0,6781	0,6761
38	0,7274	0,7254	0,7234	0,7214	0,7194	0,7174	0,7155	0,7135	0,7116	0,7096	0,7077	0,7057	0,7038	0,7019	0,6999
39	0,7496	0,7477	0,7459	0,7440	0,7422	0,7403	0,7385	0,7367	0,7348	0,7330	0,7312	0,7294	0,7276	0,7258	0,7240
40	0,7719	0,7702	0,7685	0,7668	0,7651	0,7634	0,7617	0,7600	0,7583	0,7566	0,7549	0,7532	0,7515	0,7499	0,7482
41	0,7944	0,7928	0,7912	0,7897	0,7881	0,7865	0,7850	0,7834	0,7819	0,7803	0,7788	0,7772	0,7757	0,7741	0,7726
42	0,8169	0,8155	0,8140	0,8126	0,8112	0,8098	0,8084	0,8070	0,8056	0,8042	0,8028	0,8014	0,8000	0,7986	0,7972
43	0,8395	0,8382	0,8370	0,8357	0,8344	0,8332	0,8319	0,8307	0,8294	0,8282	0,8269	0,8257	0,8244	0,8232	0,8220
44	0,8622	0,8611	0,8600	0,8589	0,8578	0,8567	0,8556	0,8545	0,8534	0,8523	0,8512	0,8501	0,8491	0,8480	0,8469
45	0,8850	0,8840	0,8831	0,8822	0,8812	0,8803	0,8794	0,8785	0,8775	0,8766	0,8757	0,8748	0,8738	0,8729	0,8720
46	0,9078	0,9071	0,9063	0,9055	0,9048	0,9040	0,9033	0,9025	0,9018	0,9010	0,9003	0,8995	0,8988	0,8980	0,8973
47	0,9307	0,9302	0,9296	0,9290	0,9284	0,9279	0,9273	0,9267	0,9261	0,9256	0,9250	0,9244	0,9239	0,9233	0,9227
48	0,9538	0,9534	0,9530	0,9526	0,9522	0,9518	0,9514	0,9510	0,9506	0,9503	0,9499	0,9495	0,9491	0,9487	0,9483
49	0,9768	0,9766	0,9764	0,9762	0,9760	0,9759	0,9757	0,9755	0,9753	0,9751	0,9749	0,9747	0,9745	0,9743	0,9741
50	1,0000	1,0000	1,0000	1,0000	1,0000	1,0000	1,0000	1,0000	1,0000	1,0000	1,0000	1,0000	1,0000	1,0000	1,0000
51	1,0232	1,0234	1,0236	1,0238	1,0240	1,0243	1,0245	1,0247	1,0249	1,0251	1,0253	1,0255	1,0257	1,0259	1,0261
52	1,0465	1,0470	1,0474	1,0478	1,0482	1,0486	1,0490	1,0494	1,0498	1,0502	1,0507	1,0511	1,0515	1,0519	1,0523
53	1,0699	1,0706	1,0712	1,0718	1,0724	1,0731	1,0737	1,0743	1,0749	1,0756	1,0762	1,0768	1,0774	1,0781	1,0787
54	1,0934	1,0942	1,0951	1,0959	1,0968	1,0976	1,0984	1,0993	1,1001	1,1010	1,1018	1,1027	1,1035	1,1044	1,1052
55	1,1169	1,1180	1,1190	1,1201	1,1212	1,1222	1,1233	1,1244	1,1255	1,1265	1,1276	1,1287	1,1298	1,1308	1,1319
56	1,1405	1,1418	1,1431	1,1444	1,1457	1,1470	1,1483	1,1496	1,1509	1,1522	1,1535	1,1548	1,1561	1,1574	1,1587
57	1,1642	1,1657	1,1672	1,1687	1,1703	1,1718	1,1733	1,1749	1,1764	1,1780	1,1795	1,1811	1,1826	1,1842	1,1857
58	1,1879	1,1896	1,1914	1,1932	1,1949	1,1967	1,1985	1,2003	1,2021	1,2039	1,2056	1,2074	1,2092	1,2110	1,2128
59	1,2117	1,2137	1,2157	1,2177	1,2197	1,2217	1,2238	1,2258	1,2278	1,2299	1,2319	1,2339	1,2360	1,2380	1,2401
60	1,2355	1,2378	1,2400	1,2423	1,2446	1,2468	1,2491	1,2514	1,2537	1,2560	1,2583	1,2606	1,2629	1,2652	1,2675
61	1,2594	1,2619	1,2645	1,2670	1,2695	1,2720	1,2746	1,2771	1,2796	1,2822	1,2847	1,2873	1,2899	1,2924	1,2950
62	1,2834	1,2862	1,2890	1,2917	1,2945	1,2973	1,3001	1,3029	1,3057	1,3085	1,3113	1,3142	1,3170	1,3198	1,3227
63	1,3075	1,3105	1,3135	1,3166	1,3196	1,3227	1,3257	1,3288	1,3319	1,3349	1,3380	1,3411	1,3442	1,3473	1,3505
64	1,3316	1,3349	1,3382	1,3415	1,3448	1,3481	1,3514	1,3548	1,3581	1,3615	1,3648	1,3682	1,3716	1,3750	1,3784
65	1,3557	1,3593	1,3629	1,3664	1,3700	1,3736	1,3772	1,3809	1,3845	1,3881	1,3918	1,3954	1,3991	1,4028	1,4065
66	1,3800	1,3838	1,3876	1,3915	1,3954	1,3992	1,4031	1,4070	1,4110	1,4149	1,4188	1,4228	1,4267	1,4307	1,4347
67	1,4042	1,4084	1,4125	1,4166	1,4208	1,4249	1,4291	1,4333	1,4375	1,4417	1,4459	1,4502	1,4544	1,4587	1,4630
68	1,4286	1,4330	1,4374	1,4418	1,4463	1,4507	1,4552	1,4597	1,4642	1,4687	1,4732	1,4777	1,4823	1,4868	1,4914
69	1,4530	1,4577	1,4624	1,4671	1,4718	1,4766	1,4813	1,4861	1,4909	1,4957	1,5005	1,5054	1,5102	1,5151	1,5200
70	1,4774	1,4824	1,4874	1,4924	1,4975	1,5025	1,5076	1,5126	1,5177	1,5229	1,5280	1,5331	1,5383	1,5435	1,5487
ΔT K \ n	1,16	1,17	1,18	1,19	1,20	1,21	1,22	1,23	1,24	1,25	1,26	1,27	1,28	1,29	1,30

1,31	1,32	1,33	1,34	1,35	1,36	1,37	1,38	1,39	1,40	1,41	1,42	1,43	1,44	1,45	n	ΔT K
0,1214	0,1195	0,1176	0,1157	0,1139	0,1120	0,1103	0,1085	0,1068	0,1051	0,1034	0,1017	0,1001	0,0985	0,0969	10	
0,1376	0,1355	0,1335	0,1315	0,1295	0,1276	0,1256	0,1237	0,1219	0,1201	0,1183	0,1165	0,1147	0,1130	0,1113	11	
0,1542	0,1520	0,1499	0,1477	0,1456	0,1436	0,1415	0,1395	0,1376	0,1356	0,1337	0,1318	0,1299	0,1281	0,1263	12	
0,1712	0,1690	0,1667	0,1645	0,1623	0,1601	0,1579	0,1558	0,1537	0,1517	0,1497	0,1477	0,1457	0,1437	0,1418	13	
0,1887	0,1863	0,1840	0,1816	0,1793	0,1771	0,1748	0,1726	0,1704	0,1683	0,1661	0,1640	0,1620	0,1599	0,1579	14	
0,2066	0,2041	0,2016	0,1992	0,1968	0,1945	0,1922	0,1899	0,1876	0,1853	0,1831	0,1809	0,1788	0,1766	0,1745	15	
0,2248	0,2222	0,2197	0,2172	0,2148	0,2123	0,2099	0,2075	0,2052	0,2029	0,2006	0,1983	0,1960	0,1938	0,1916	16	
0,2434	0,2407	0,2382	0,2356	0,2331	0,2306	0,2281	0,2257	0,2232	0,2208	0,2185	0,2161	0,2138	0,2115	0,2092	17	
0,2623	0,2596	0,2570	0,2544	0,2518	0,2492	0,2467	0,2442	0,2417	0,2392	0,2368	0,2344	0,2320	0,2297	0,2273	18	
0,2815	0,2788	0,2761	0,2735	0,2708	0,2682	0,2656	0,2631	0,2606	0,2580	0,2556	0,2531	0,2507	0,2482	0,2459	19	
0,3011	0,2983	0,2956	0,2929	0,2903	0,2876	0,2850	0,2824	0,2798	0,2773	0,2747	0,2722	0,2697	0,2673	0,2648	20	
0,3210	0,3182	0,3154	0,3127	0,3100	0,3073	0,3047	0,3021	0,2994	0,2969	0,2943	0,2918	0,2892	0,2867	0,2843	21	
0,3411	0,3383	0,3356	0,3328	0,3301	0,3274	0,3247	0,3221	0,3194	0,3168	0,3142	0,3117	0,3091	0,3066	0,3041	22	
0,3616	0,3588	0,3560	0,3533	0,3505	0,3478	0,3451	0,3425	0,3398	0,3372	0,3346	0,3320	0,3294	0,3269	0,3243	23	
0,3823	0,3795	0,3767	0,3740	0,3713	0,3685	0,3658	0,3632	0,3605	0,3579	0,3553	0,3527	0,3501	0,3475	0,3450	24	
0,4033	0,4005	0,3978	0,3950	0,3923	0,3896	0,3869	0,3842	0,3816	0,3789	0,3763	0,3737	0,3711	0,3686	0,3660	25	
0,4246	0,4218	0,4191	0,4163	0,4136	0,4109	0,4082	0,4056	0,4029	0,4003	0,3977	0,3951	0,3925	0,3900	0,3874	26	
0,4461	0,4434	0,4406	0,4379	0,4352	0,4326	0,4299	0,4273	0,4246	0,4220	0,4194	0,4169	0,4143	0,4118	0,4092	27	
0,4679	0,4652	0,4625	0,4598	0,4571	0,4545	0,4519	0,4493	0,4467	0,4441	0,4415	0,4390	0,4364	0,4339	0,4314	28	
0,4899	0,4872	0,4846	0,4819	0,4793	0,4767	0,4741	0,4716	0,4690	0,4664	0,4639	0,4614	0,4589	0,4564	0,4539	29	
0,5121	0,5095	0,5069	0,5043	0,5018	0,4992	0,4967	0,4941	0,4916	0,4891	0,4866	0,4841	0,4817	0,4792	0,4768	30	
0,5346	0,5321	0,5295	0,5270	0,5245	0,5220	0,5195	0,5170	0,5145	0,5121	0,5097	0,5072	0,5048	0,5024	0,5000	31	
0,5573	0,5548	0,5524	0,5499	0,5474	0,5450	0,5426	0,5402	0,5378	0,5354	0,5330	0,5306	0,5282	0,5259	0,5236	32	
0,5802	0,5778	0,5754	0,5730	0,5707	0,5683	0,5659	0,5636	0,5613	0,5589	0,5566	0,5543	0,5520	0,5497	0,5474	33	
0,6034	0,6011	0,5987	0,5964	0,5941	0,5919	0,5896	0,5873	0,5850	0,5828	0,5805	0,5783	0,5761	0,5739	0,5717	34	
0,6267	0,6245	0,6223	0,6201	0,6178	0,6156	0,6135	0,6113	0,6091	0,6069	0,6048	0,6026	0,6005	0,5983	0,5962	35	
0,6503	0,6482	0,6460	0,6439	0,6418	0,6397	0,6376	0,6355	0,6334	0,6313	0,6293	0,6272	0,6252	0,6231	0,6211	36	
0,6741	0,6720	0,6700	0,6680	0,6660	0,6640	0,6620	0,6600	0,6580	0,6560	0,6541	0,6521	0,6501	0,6482	0,6462	37	
0,6980	0,6961	0,6942	0,6923	0,6904	0,6885	0,6866	0,6847	0,6829	0,6810	0,6791	0,6773	0,6754	0,6736	0,6717	38	
0,7222	0,7204	0,7186	0,7168	0,7150	0,7133	0,7115	0,7097	0,7080	0,7062	0,7045	0,7027	0,7010	0,6992	0,6975	39	
0,7465	0,7449	0,7432	0,7416	0,7399	0,7382	0,7366	0,7350	0,7333	0,7317	0,7301	0,7284	0,7268	0,7252	0,7236	40	
0,7711	0,7695	0,7680	0,7665	0,7650	0,7635	0,7619	0,7604	0,7589	0,7574	0,7559	0,7544	0,7529	0,7514	0,7499	41	
0,7958	0,7944	0,7930	0,7917	0,7903	0,7889	0,7875	0,7861	0,7848	0,7834	0,7820	0,7807	0,7793	0,7780	0,7766	42	
0,8207	0,8195	0,8182	0,8170	0,8158	0,8146	0,8133	0,8121	0,8109	0,8097	0,8084	0,8072	0,8060	0,8048	0,8036	43	
0,8458	0,8447	0,8436	0,8426	0,8415	0,8404	0,8393	0,8383	0,8372	0,8361	0,8351	0,8340	0,8329	0,8319	0,8308	44	
0,8711	0,8702	0,8692	0,8683	0,8674	0,8665	0,8656	0,8647	0,8638	0,8629	0,8619	0,8610	0,8601	0,8592	0,8583	45	
0,8965	0,8958	0,8950	0,8943	0,8935	0,8928	0,8921	0,8913	0,8906	0,8898	0,8891	0,8883	0,8876	0,8869	0,8861	46	
0,9221	0,9216	0,9210	0,9204	0,9199	0,9193	0,9187	0,9182	0,9176	0,9170	0,9165	0,9159	0,9153	0,9148	0,9142	47	
0,9479	0,9475	0,9472	0,9468	0,9464	0,9460	0,9456	0,9452	0,9448	0,9445	0,9441	0,9437	0,9433	0,9429	0,9425	48	
0,9739	0,9737	0,9735	0,9733	0,9731	0,9729	0,9727	0,9725	0,9723	0,9721	0,9719	0,9717	0,9715	0,9713	0,9711	49	
1,0000	1,0000	1,0000	1,0000	1,0000	1,0000	1,0000	1,0000	1,0000	1,0000	1,0000	1,0000	1,0000	1,0000	1,0000	50	
1,0263	1,0265	1,0267	1,0269	1,0271	1,0273	1,0275	1,0277	1,0279	1,0281	1,0283	1,0285	1,0287	1,0289	1,0291	51	
1,0527	1,0531	1,0535	1,0540	1,0544	1,0548	1,0552	1,0556	1,0560	1,0564	1,0569	1,0573	1,0577	1,0581	1,0585	52	
1,0793	1,0800	1,0806	1,0812	1,0818	1,0825	1,0831	1,0837	1,0844	1,0850	1,0856	1,0863	1,0869	1,0875	1,0882	53	
1,1061	1,1069	1,1078	1,1086	1,1095	1,1103	1,1112	1,1121	1,1129	1,1138	1,1146	1,1155	1,1163	1,1172	1,1181	54	
1,1330	1,1341	1,1351	1,1362	1,1373	1,1384	1,1395	1,1406	1,1417	1,1427	1,1438	1,1449	1,1460	1,1471	1,1482	55	
1,1600	1,1614	1,1627	1,1640	1,1653	1,1666	1,1680	1,1693	1,1706	1,1719	1,1733	1,1746	1,1759	1,1773	1,1786	56	
1,1873	1,1888	1,1904	1,1919	1,1935	1,1951	1,1966	1,1982	1,1998	1,2013	1,2029	1,2045	1,2061	1,2077	1,2092	57	
1,2146	1,2164	1,2182	1,2200	1,2219	1,2237	1,2255	1,2273	1,2291	1,2310	1,2328	1,2346	1,2364	1,2383	1,2401	58	
1,2421	1,2442	1,2462	1,2483	1,2504	1,2524	1,2545	1,2566	1,2587	1,2608	1,2629	1,2649	1,2670	1,2691	1,2712	59	
1,2698	1,2721	1,2744	1,2767	1,2791	1,2814	1,2837	1,2861	1,2884	1,2908	1,2931	1,2955	1,2979	1,3002	1,3026	60	
1,2976	1,3002	1,3027	1,3053	1,3079	1,3105	1,3131	1,3158	1,3184	1,3210	1,3236	1,3263	1,3289	1,3316	1,3342	61	
1,3255	1,3284	1,3312	1,3341	1,3370	1,3398	1,3427	1,3456	1,3485	1,3514	1,3543	1,3572	1,3602	1,3631	1,3660	62	
1,3536	1,3567	1,3599	1,3630	1,3662	1,3693	1,3725	1,3757	1,3788	1,3820	1,3852	1,3884	1,3916	1,3949	1,3981	63	
1,3818	1,3852	1,3886	1,3921	1,3955	1,3990	1,4024	1,4059	1,4094	1,4128	1,4163	1,4198	1,4233	1,4269	1,4304	64	
1,4102	1,4139	1,4176	1,4213	1,4250	1,4288	1,4325	1,4363	1,4401	1,4438	1,4476	1,4514	1,4553	1,4591	1,4629	65	
1,4386	1,4426	1,4466	1,4507	1,4547	1,4587	1,4628	1,4669	1,4709	1,4750	1,4791	1,4833	1,4874	1,4915	1,4957	66	
1,4673	1,4716	1,4759	1,4802	1,4845	1,4889	1,4933	1,4976	1,5020	1,5064	1,5108	1,5153	1,5197	1,5242	1,5286	67	
1,4960	1,5006	1,5052	1,5099	1,5145	1,5192	1,5239	1,5286	1,5333	1,5380	1,5427	1,5475	1,5522	1,5570	1,5618	68	
1,5249	1,5298	1,5348	1,5397	1,5447	1,5497	1,5547	1,5597	1,5647	1,5698	1,5748	1,5799	1,5850	1,5901	1,5952	69	
1,5539	1,5592	1,5644	1,5697	1,5750	1,5803	1,5856	1,5910	1,5963	1,6017	1,6071	1,6125	1,6179	1,6234	1,6289	70	
1,31	1,32	1,33	1,34	1,35	1,36	1,37	1,38	1,39	1,40	1,41	1,42	1,43	1,44	1,45	n	ΔT K

Notes

zehnder *radiavector*

zehnder

Zehnder Ltd
B15 Armstrong Mall
Southwood Business Park
Farnborough, Hants. GU14 0NR

Tel. +44 (0) 1252 515151
Fax +44 (0) 1252 522528
sales@zehnder.co.uk
www.zehnder.co.uk

zehnder